

Application of Improved GMDH Models to Predict Local Scour Depth at Complex Bridge Piers

Habibeh Ghodsi ^{a*}, Mohammad Javad Khanjani ^b

^a Ph.D., Civil Engineering Department, Shahid Bahonar University of Kerman, Kerman, Iran.

^b Professor, Civil Engineering Department, Shahid Bahonar University of Kerman, Kerman, Iran.

Received 09 September 2019; Accepted 14 December 2019

Abstract

Scour depth prediction is a vital issue in bridge pier design. Recently, good progress has been made in the development of artificial intelligence (AI) to predict scour depth around hydraulic structures base such as bridge piers. In this study, two hybrid intelligence models based on combination of group method of data handling (GMDH) with harmony search algorithm (HS) and shuffled complex evolution (SCE) have been developed to predict local scour depth around complex bridge piers using 82 laboratory data measured by authors and 615 data points from published literature. The results were compared to conventional GMDH models with two kinds of transfer functions called GMDH1 and GMDH2. Based upon the pile cap location, data points were divided into three categories. The performance of all utilized models was evaluated by statistical criteria of R, RMSE, MAPE, BIAS, and SI. Performances of developed models were evaluated by experimental data points collected in laboratory experiments, together with commonly empirical equations. The results showed that GMDH2SCE was the superior model in terms of all the statistical criteria in training when the pile cap was above the initial bed level and completely buried pile cap. For a partially-buried pile cap, GMDH1SCE offered the best performance. Among empirical equations, HEC-18 produced relatively good performances for different types of complex piers. This study recommends hybrid GMDH models, as powerful tools in complex bridge pier scour depth prediction.

Keywords: Scour Depth Prediction; Complex Bridge Pier; Artificial Intelligence Method; GMDH.

1. Introduction

Physical and economic considerations may lead to complex bridge pier design. Complex piers are commonly constructed of columns and pile caps which are founded on pile groups. Schematic view of complex pier is presented in Figure 1 in which L_c = column length; L_{pc} = pile cap length; b_c = column width; b_{pc} = pile cap width; b_{pg} = pile diameter; S_l = pile spacing in line with flow; S_b = pile spacing normal to the flow; L_u and L_f = extension of the pile cap upstream of and sides of the column, respectively; T = pile cap thickness; Y = pile cap top elevation to the initial bed level. This structure is embedded in the coastal and river environments. The interaction between these structures and their environments may lead to the scour process. Scouring could reduce the stability of these structures and they may collapse. By designing laboratory tests by authors, 82 experimental data points were measured experimentally [1]. Also 615 experimental data sets with the same measured experimental conditions were collected from published literature to evaluate the effects of geometric parameters on complex pier scour depth. Experiments were executed with six complex pier models to quantify the influence of the pile cap upstream extension, pile group arrangement, pile group upstream extension, and pile cap thickness. In these studies, authors tried to find the relationship between the upper limit of the

* Corresponding author: habibeh.ghodsi@gmail.com

 <http://dx.doi.org/10.28991/cej-2020-03091454>



© 2019 by the authors. Licensee C.E.J, Tehran, Iran. This article is an open access article distributed under the terms and conditions of the Creative Commons Attribution (CC-BY) license (<http://creativecommons.org/licenses/by/4.0/>).

pile cap undercut elevation and the pile cap thickness. A few experimental and numerical investigations have been carried out to predict scour depth around complex bridge piers [2-6]. By comparing the results of theoretical and empirical equations, it was obvious that they are not accurate enough to predict scour depth. Because empirical equations such as HEC-18 and FDOT are limited to the experimental and field data base and do not consider all of the conditions. In many years, researchers have been concentrated on presenting empirical formulas to predict scour depth at bridge piers. Because of many limitations, these formulas work in a specific range of experimental conditions. To overcome these difficulties, the focus of researchers has turned to use Artificial Intelligence (AI) method for prediction of bridge pier scour depth. Recently, different artificial intelligence approaches such as artificial neural networks (ANN), adaptive Neuro-Fuzzy inference systems (ANFIS), genetic programming (GP), gene-expression programming (GEP), support vector machines (SVM), model trees (MT), evolutionary polynomial regressions (EPR), POS-SVM, multivariate adaptive regression splines (MARS), and self-adaptive extreme learning machines (SAELM) have been applied to predict the local scour depth around hydraulic structures [7-16]. Among these soft computing techniques, group method of data handling (GMDH) methods were widely applied to predict the local scour depth around bridge piers and abutments, downstream of ski-jump bucket spillways, downstream of grade-control structures, and below pipelines induced currents and waves [17-20]. Through these applications, general structure of the GMDH network was easily developed by evolutionary algorithms genetic algorithm (GA), gravitational search algorithm (GSA), particle swarm optimization (PSO), and Neuro-Fuzzy (NF) in order to predict local scour depth at hydraulic structures. Previous investigations established that improvement of GMDH model using other evolutionary algorithms had a successful performance in the prediction of the local scour depth.

The main objective of this study is to develop the GMDH network by means of two evolutionary algorithms as, harmonic search (HS) and shuffled complex evolution (SCE) to predict scour depth around complex bridge piers. A large set of data including 697 datasets were used to evaluate the ability of developed models. After training and testing stages of the proposed GMDH networks, all the performances related to the GMDH-HS and GMDH-SCE were evaluated quantitatively and qualitatively (R, RMSE, MAPE, BIAS, and SI). Furthermore, the results of the developed models were compared with those obtained using empirical equations in terms of precision level.

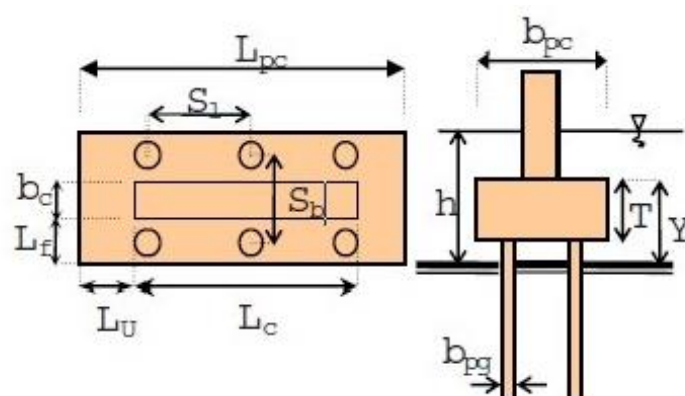

Figure 1. Complex pier geometry characteristics

2. Review of Experimental Study

Local scour depth estimation around the bridge pier is a vital issue in bridges foundation design. Various design methods and formulas have been used to estimate local scour depth at the vicinity of bridge piers. Raudkivi described the effects of the flow and sediment parameters on the local scour around piers and discussed the functional trends of local scour based on laboratory data [21]. Melville comprehensively investigated the effective parameters in the pier and abutment scour and presented empirical relations that is called K-factors [22]. Also Ettema *et al.* discussed the effects of skew factors on scour geometry [23].

Salim and Jones studied the scour around submerged and un-submerged pile groups and presented several equations for the effect of pile spacing and attack angle [24]. Zhao and Sheppard investigated the effect of attack angle on local scour in pile groups [25]. Ataie-Ashtiani and Beheshti conducted an experimental study on pile groups and suggested a correction factor to estimate maximum local scour [26]. Sumer *et al.* described scour geometry for pile groups with varying pile spacing [27]. Accordingly, scour around pile groups is caused by two mechanisms: first, causing local scour in individual piles and, second, causing a global scour (general lowering of the bed) over the entire area of the pile group. Dey *et al.* introduced a submerged factor to determine the scour depth in a submerged cylinder from the information of the scour depth in an un-submerged cylinder with same diameter [28]. Amini *et al.* evaluated the commonly used equations to estimate the local scour depth in a group of piles for different spacing, arrangements, and submergences [29].

Circular compound pier and caissons local scour have been experimentally studied. Melville and Raudkivi studied the influence of the ratio of pier width to foundation width and scour depth at a non-uniform pier based on laboratory data [30].

Physical and economic considerations often lead to bridge foundations designed including of a column founded on a pile cap supported by an array of piles. Piers of this configuration are referred to as complex piers [3]. Knowledge about local scour depth and scour mechanisms around complex piers has been investigated by many researchers [2-5, 31-37]. All of research workers tried to develop a semi-empirical model to estimate the scour depth in non-uniform piers and complex piers with unexposed foundations using the concept of the primary vortex and sediment transport theory.

3. Dimensional Analysis

The functional relationship to investigate the effect of pier, fluid, bed sediments, and fully turbulent flow factors on scour depth, y_s , at single uniform pier could be presented as [23]:

$$y_s = f_1(\rho, \mu, U, h, g, d_{50}, U_c, D) \quad (1)$$

Where ρ = the fluid density, μ = the fluid viscosity, U = the average velocity of approach flow, h = the flow depth, g = the gravitational acceleration, d_{50} = the median particle size of sediment bed, U_c = the critical value of U associated with initiation of motion of bed sediments, and D = the pier diameter. By using the dimensional analysis Equation 1 can be expressed as:

$$\frac{y_s}{D} = f_2\left(\frac{U}{U_c}, \frac{U^2}{gD}, \frac{h}{D}, \frac{D}{d_{50}}, \frac{\rho UD}{\mu}\right) \quad (2)$$

Similarly, the following functional relationship for complex piers presented as:

$$\frac{y_s}{D_c} \text{ or } \frac{b_e}{D_c} = f_3\left(\frac{U}{U_c} \text{ or } Fr, \frac{h}{D_c}, \frac{D_c}{D_{pc}}, \frac{T}{D_{pc}}, \frac{Y}{D_{pc}}, \frac{f_{cu}}{D_c}, \frac{f_{cs}}{D_c}, k_{sc}, k_{spc}, \frac{b_{pg}}{D_c}, m, n, \frac{S_n}{b_{pg}}, \frac{S_m}{b_{pg}}\right) \quad (3)$$

Where D_c =column width, D_{pc} =pile cap width, T =pile cap thickness, f_{cu} and f_{cs} =upstream and side extensions of the pile cap with respect to the column, respectively, k_{sc} and k_{spc} =shape factors for the column and pile cap, respectively, as recommended by Melville and Coleman (2000), b_{pg} =pile diameter, m =number of piles in line with the flow, n =number of piles normal to the flow, S_m = pile spacing in the flow direction, S_n = pile spacing normal to flow, Fr = Froude number, U = mean velocity of the approach flow, and U_c = critical mean velocity for particle motion.

4. Description of Data Collection

In this study, to investigate the scour depth prediction around complex bridge piers, 615 data points were collected from various literatures [3-5, 33-35, 38-43]. Overall, 615 data points were obtained from published literatures. The characteristics of collected data points are summarized in Table 1. In the case of application of GMDH model in the scour depth prediction, previous investigations have demonstrated that the performance of dimensionless parameters had more accurate prediction of scour depth than dimensional parameters applied in modelling the local scour prediction [44]. Hence, the following function can characterize the scour depth (output) and input (or independent) variables as Equation 3.

Equation 3 is applied for both buried and partially buried pile caps. When pile cap is above the initial bed level, functional relationship for maximum scour depth can be expressed as:

$$\frac{y_s}{D_c} \text{ or } \frac{b_e}{D_c} = f_4\left(\frac{U}{U_c}, \frac{D_c}{D_{pc}}, \frac{Y}{h}, \frac{Y}{D_c}, \frac{f_{cu}}{D_c}, \frac{f_{pm}}{D_c}, m, n, \frac{b_{pg}}{D_c}, \frac{S_m}{b_{pg}}, \frac{S_n}{b_{pg}}\right) \quad (4)$$

According to the pile cap position: pile cap was above the initial bed level, partially-buried pile cap, and totally buried pile cap, the scour depth prediction problem categorized in three groups (Figure 2). Figure 3 illustrates the schematic process of the present study.

The dimensionless parameters mentioned in Equation 3 were used as input parameters in the development of models. The ranges of data sets are presented in Table 1. In this study, about 80 % of data sets were selected randomly for the training stage, whereas the remaining 20 % were used for the testing stage.

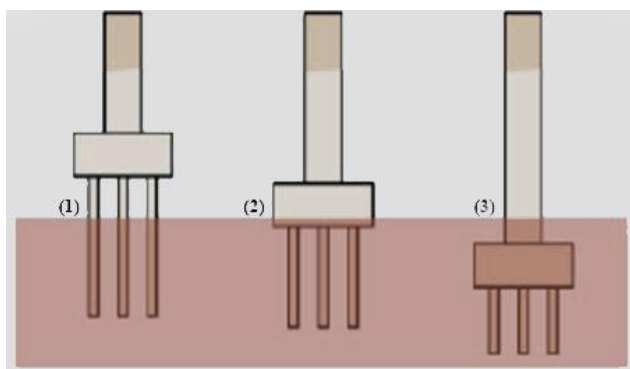

Figure 2. Schematic view of three different of pile cap elevation: (1) pile cap above the initial bed level, (2) partially-buried pile cap, and (3) completely buried pile cap

5. Introduction Advantages of GMDH Technique

The GMDH is a heuristic self-organizing modeling method which Ivakhnenko has developed for modeling purpose as a rival method of stochastic approximation. GMDH is ideal for complex, unstructured systems where the investigator is only interested in obtaining a high-order input-output relationship. Alternatively, soft-computing methods, which concern computation in an imprecise environment, have gained significant attention. The main components of soft computing, namely, fuzzy logic, neural network, and evolutionary algorithms have shown great ability in solving complex non-linear system identification and control problems. Many research efforts have been expended to use of evolutionary methods as effective tools for system identification. Among these methodologies, Group Method of Data Handling (GMDH) algorithm is a self-organizing approach by which gradually complicated models are generated based on the elevation of their performances on a set of multi-input-single-output data pairs. The GMDH was first developed by Ivakhnenko as a multivariate analysis method for complex systems modeling and identification. In this way, GMDH was used to circumvent the difficulty of knowing a prior knowledge of mathematical model of the process being considered. Therefore, GMDH can be used to model complex systems without having specific knowledge of the systems. The main idea of GMDH is to build an analytical function in a feed-forward network based on a quadratic node transfer function whose coefficients are obtained using regression technique. The advantage of using pairs of input is that only six weights (coefficients) have to be computed for each neuron. The number of neurons in each layer increases approximately as the square of number of inputs. During each training cycle, the synaptic weights of each neuron that minimize the error norm between predicted and measured. There could be summarized that the GMDH-type polynomial networks influence be contemporary artificial neural network algorithms with several other advantages: They offer adaptive network representations that can be tailored to the given task; They learn the weights rapidly in a single step by standard ordinary least squares (OLS) fitting which eliminates the need to search for their values, and which guarantees finding locally good weights due to the reliability of the fitting technique; Those polynomial networks feature sparse connectivity which means that the best discovered networks can be trained fast [44].

6. Development of GMDH Network

In GMDH network, a set of neurons in each layer connected by quadratic (GMDH2) or nonlinear (GMDH1) polynomial and produced the new neurons in next layer. The learning of GMDH network is explained in brief for data series 3 with seven variables. The weighting coefficients of quadratic polynomial were determined using least square estimation method from input layer to output layer. In this study, number of neurons used in GMDH structure is 21 and 6 of them are the selective neurons that have been selected based on minimum correlation determination. By executing the model, the weights, the computational output and the coefficient determination are calculated between the computational outputs in each neuron. After implementation of the GMDH model, in the first layer, the criteria of correlation determination is considered 0.295 to select the best neurons. The variables y_1^1 , y_2^1 , y_3^1 , y_4^1 , y_5^1 and y_6^1 are selected to form the second layer. These outputs account for 15 neurons in the second layer. Similarly, variables y_1^2 , y_2^2 , y_3^2 , y_4^2 and y_5^2 are chosen to form the third layer. These selected outputs account for 10 neurons in the third layer. Variables y_1^3 , y_2^3 , y_3^3 and y_4^3 are selected to form the fourth layer. These outputs make up 6 neurons in the fourth layer. The variables y_1^4 , y_2^4 and y_3^4 are selected to form the fifth layer. These outputs make up 3 neurons in the fifth layer. The variables y_1^5 and y_2^5 are used to form the sixth layer. These outputs comprise 1 neuron in the sixth layer. Since there is only one neuron in the sixth layer, the y_1^6 equation is chosen as the final output. Figure 4 showed structure of the GMDH network. The equations of each layer for predicting scour depth in GMDH2 model presented as follows:

Table 1. Summary of experimental data used in evolution of GMDH models

Researcher(s)	h (cm)	u/u_c	d_{50}	Y (cm)	T (cm)	b_{pg} (cm)	Column shap	Pile cap shape
Parola et al. (1996)	15	0.95	0.58	-15-6.9	0.05-25.23	-	rectangular	rectangular
Melville and Raudkivi (1996)	20	1	0.24, 0.8	-20-9	8.37-32.27	?	circular	circular
Fotherby and Jones (1993)	30.48	1.183	1	-3-15.24	3	?	rectangular	rectangular
Coleman (2005)	33- 60	0.75-0.85	0.84	-66-21.0007	6-8	2-2.4	rectangular	rectangular
Ataie-Ashtiani et al. (2010)	14- 60	0.71-0.86	0.6	-3.7-2.3	3.2-∞	1.6	rectangular	rectangular
Ferraro et al. (2013)	10	0.92	0.83	-12.4-5	0.1, 5	2.5	Rounded rectangular	Rounded rectangular
Oliveto, Rossi, and Hger (2004)	10- 20	0.58-0.93	1.7- 2.4	0- 7.3	4-8	2-4	circular	square
Lu et al. (2011)	17.9- 20.4	0.65- 0.9	0.52	-5- 3	?	?	rectangular	rectangular
Kothyari and Kumar (2012)	16.5	0.75	0.4	0- 2.1	33- 64	?	circular	?
Martine-Vide et al. (1996)	25.4	0.927	0.65	-25.4	26.4- 40.4	6	rectangular	Circular
Sheppard et al. (2004)	32.6- 33.5	1.5- 3.08	0.84	-22.86- (-10.36)	8	2.5	rectangular	rectangular
Beheshti and Ataie-Ashtiani (2010)	0.2853	1	0.71	-6.15	3.36	2.54	rectangular	rectangular
Zhao	21.3- 21.5	0.64- 0.65	0.17	-	-	3.18	-	-
Hannah	14	0.7723	0.75	-	-	3.3	---	-
Present study	19.4- 22.6	0.8- 0.96	0.71	-8- 2	3	2	rectangular	rectangular

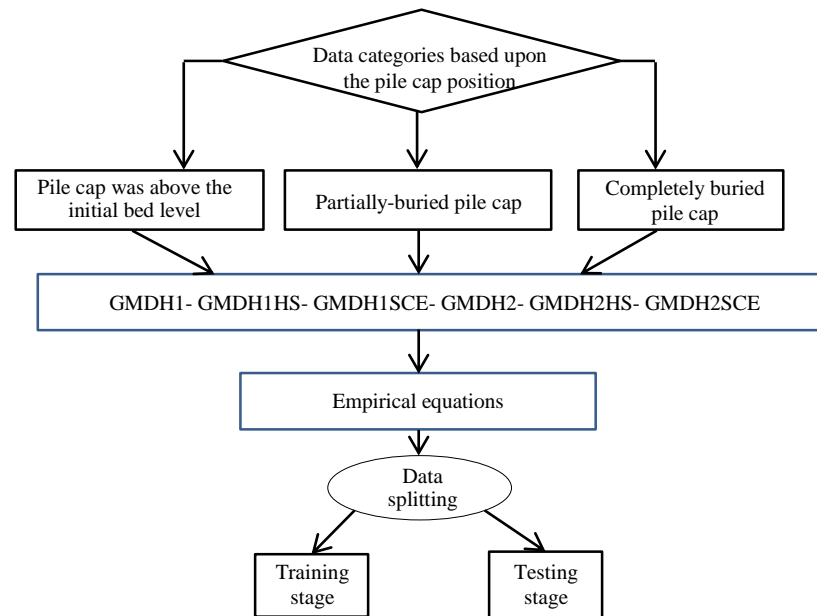

Figure 3. Schematic presentation of the study

First the data sets divided into three categories based upon the pile cap elevation, second. Each of the categories run with the hybrid GMDH method, finally, the results compared with the empirical equations estimations.

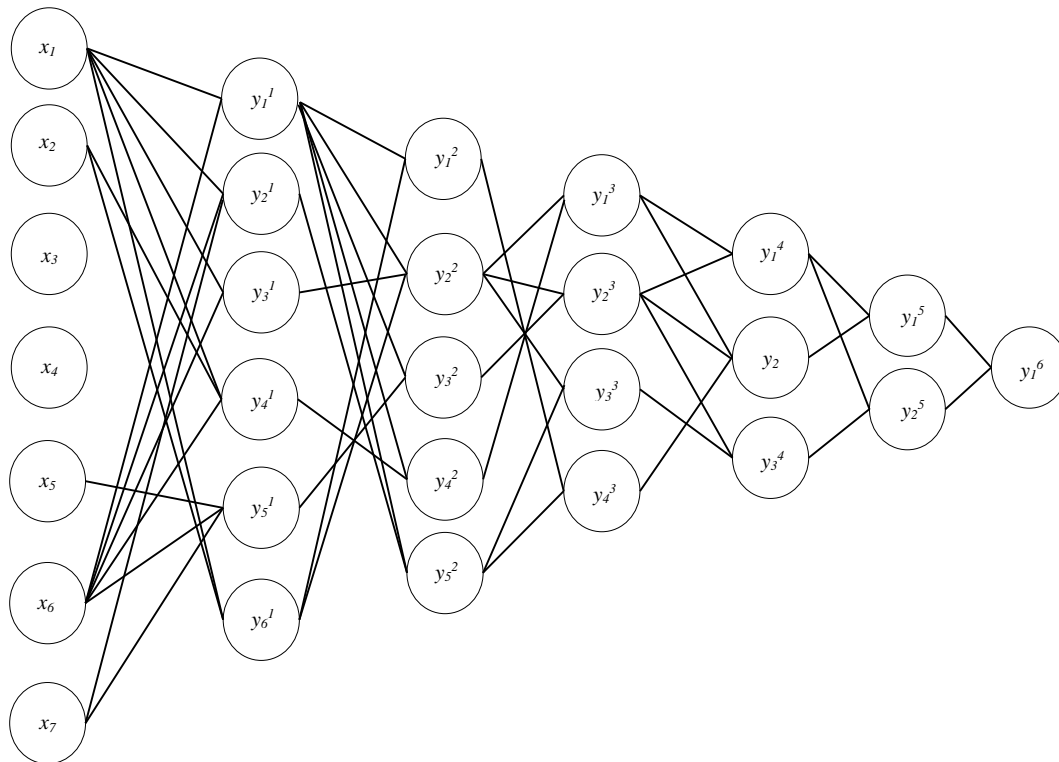

Figure 4. General structure of the GMDH2 network

layer (2)

$$\begin{aligned}
 y_1^1 &= 5.4688 - 16.3001x_1 - 0.4206x_6 + 2.166x_1^2 + 16.3541x_6^2 - 0.0059x_1x_6 \\
 y_2^1 &= -11.1285 - 72.2730x_1 - 0.4206x_6 + 0.6816x_7 - 25.1909x_1^2 - 11.1636x_1^2 + 2.0447x_1x_7 \\
 y_3^1 &= -12.03 + 46.808x_1 - 0.4206x_6 - 19.8633x_2 - 12.2285x_1^2 - 10.2434x_6^2 - 7.4574x_1x_2 \\
 y_4^1 &= 12.03 + 46.808x_1 - 0.4206x_6 - 19.8633x_2 - 12.2285x_1^2 - 10.2434x_6^2 - 7.4574x_1x_2 \\
 y_5^1 &= 6.19 + 34.34x_5 - 5.22x_7 - 13.78x_5^2 - 1.9x_7^2 - 10.2434x_6^2 + 1.928x_5x_7 \\
 y_6^1 &= -0.598 + 23.2x_1 - 10.15x_2 + 17.26x_1^2 - 17.32x_2^2 + 6.49x_1x_2
 \end{aligned}$$

layer (3)

$$\begin{aligned}
 y_1^2 &= -0.886 + 0.592y_1^1 + 0.86y_6^1 - 0.159(y_1^1)^2 + 0.077(y_6^1)^2 + 0.032y_1^1y_6^1 \\
 y_2^2 &= 0.38 + 0.256y_1^1 + 0.767y_3^1 - 0.079(y_1^1)^2 + 0.077(y_6^1)^2 - 0.009y_1^1y_6^1 \\
 y_3^2 &= -0.404 + 0.637y_1^1 + 0.283y_5^1 + 0.003(y_1^1)^2 + 0.009(y_5^1)^2 - 0.001y_1^1y_5^1 \\
 y_4^2 &= 1.417 + 0.4643y_1^1 + 0.134y_4^1 + 0.028(y_1^1)^2 + 0.066(y_1^1)^2 - 0.013y_1^1y_4^1 \\
 y_5^2 &= 0.674 + 0.3936y_1^1 + 0.383y_2^1 - 0.005(y_1^1)^2 + 0.021(y_2^1)^2 + 0.006y_1^1y_2^1
 \end{aligned}$$

layer (4)

$$\begin{aligned}
 y_1^3 &= -1.215 + 2.576y_2^2 - 1.3y_4^2 - 0.109(y_2^2)^2 - 0.006(y_4^2)^2 + 0.104y_2^2y_4^2 \\
 y_2^3 &= -1.67 + 2.9046y_2^2 - 1.547y_3^2 - 0.315(y_2^2)^2 + 0.086(y_3^2)^2 + 0.216y_2^2y_3^2 \\
 y_3^3 &= -1.01 + 2.019y_2^2 - 0.802y_5^2 + 1.023(y_2^2)^2 - 0.525(y_5^2)^2 - 0.2y_2^2y_5^2 \\
 y_4^3 &= -0.821 + 2.037y_1^2 - 0.861y_5^2 + 1.355(y_1^2)^2 - 0.694(y_5^2)^2 - 0.66y_1^2y_5^2
 \end{aligned}$$

layer (5)

$$\begin{aligned}
 y_1^4 &= 1.898 + 1.0936y_1^3 - 0.547y_2^3 + 0.241(y_1^3)^2 - 0.127(y_2^3)^2 - 0.0931y_1^3y_2^3 \\
 y_2^4 &= 1.361 + 0.876y_1^3 - 0.202y_4^3 + 0.157(y_2^3)^2 - 0.082(y_4^3)^2 - 0.061y_1^3y_4^3 \\
 y_3^4 &= 1.591 + 0.754y_2^3 - 0.133y_3^3 + 0.158(y_2^3)^2 - 0.081(y_3^3)^2 - 0.061y_2^3y_3^3
 \end{aligned}$$

layer (6)

$$\begin{aligned}
 y_1^5 &= 0.275 + 0.7946y_1^4 + 0.1368y_2^4 - 7.665(y_1^4)^2 + 3.884(y_2^4)^2 + 3.782y_1^4y_2^4 \\
 y_2^5 &= -0.217 + 0.841y_1^4 + 0.205y_3^4 - 0.569(y_1^4)^2 + 0.304(y_3^4)^2 + 0.264y_1^4y_3^4
 \end{aligned}$$

layer (7)

$$y_1^6 = -0.944 + 2.4661y_1^5 - 1.2848y_2^5 - 2.25(y_1^5)^2 + 1.03(y_2^5)^2 + 1.215y_1^5y_2^5$$

y_{ij} indicated that output of neuron i in layer j .

7. Results and Discussions

In this paper, the capability of hybrid GMDH models in predicting the pier scour depth was comparatively investigated by a large set of experimental scour data. The results of GMDH networks including GMDH1, GMDH1HS, GMDH1SCE, GMDH2, GMDH2HS, and GMDH2SCE are presented in this section. The performance results were compared with those obtained by empirical equations such as HEC-18, FDOT, Coleman [2], revised HEC-18, and revised Coleman. Correlation coefficient (R), root mean square error (RMSE), mean absolute percentage error (MAPE), BIAS, and scatter index (SI) can be defined to evaluate error indicators in the training and testing stages. The results of training and testing stage performances are presented in Tables 2 to 4. The comparison of GMDH models performances are schematically illustrated in Figures 5 to 7 in for 1, 2, and 3 data series.

$$R = \frac{\sum_1^N (y_{i(o)} - \bar{y}_{(o)}) (y_{i(p)} - \bar{y}_{(p)})}{\sqrt{\sum_1^N (y_{i(o)} - \bar{y}_{(o)})^2 \sum_1^N (y_{i(p)} - \bar{y}_{(p)})^2}} \quad (5)$$

$$RMSE = \left[\frac{\sum_1^N (y_{i(p)} - y_{i(o)})^2}{N} \right]^{\frac{1}{2}} \quad (6)$$

$$MAPE = \frac{1}{N} \left[\frac{\sum_1^N |y_{i(p)} - y_{i(o)}|}{\sum_1^N y_{i(o)}} \times 100 \right] \quad (7)$$

$$BIAS = \sum_1^N \frac{(y_{i(p)} - y_{i(o)})}{N} \quad (8)$$

$$SI = \frac{\sqrt{\frac{\sum_1^N ((y_{i(p)} - \bar{y}_{(p)}) - (y_{i(o)} - \bar{y}_{(o)}))^2}{N}}}{\frac{\sum_1^N y_{i(o)}}{N}} \quad (9)$$

Where y_p is the predicted values (network output), and y_o is the observed values, and N is the total of events.

Through the training stage, it can be concluded that the GMDH2SCE, produced more accurate performance (RMSE=1.121, MAPE=0.139, BIAS=1.39E-14, SI=0.190) compared to the other models, in data series 1, when the pile cap was above the initial bed level. Once the pile cap was partially-buried, the GMDH2HS and GMDH1SCE produced lower error parameters (RMSE=2.198, MAPE=0.183, and RMSE=2.744, MAPE=0.190, respectively) than that GMDH1, GMDH2, GMDH1HS, and GMDH2SCE in data series 2. In the case of completely buried pile cap, the results showed that the GMDH1SCE and GMDH2SCE indicated lower error and higher correlation coefficient index (R=0.927, RMSE=2.514, MAPE=0.228, BIAS=-1.49E-08, SI=0.313 and R=0.928, RMSE=2.510, MAPE=0.228, BIAS=-0.010, SI=0.312), compared to the other models.

In the testing stage, according to Table 3 (pile cap was above the initial bed level), and it can be concluded that GMDH1SCE and GMDH2SCE predicted scour depth with a more accurate performance (R=0.923, RMSE=1.602, MAPE=0.663, BIAS=0.288, SI=0.222) compared to the GMDH1, GMDH2, GMDH1HS, and GMDH2HS models. For partially-buried pile cap, the results from Table 4 indicate that all of the applied models had the same performance in estimating scour depth around complex piers based upon the statistical indices (R=0.856, RMSE=3.239, MAPE=35.988, BIAS=1.106, SI=0.413). In the situation of completely buried pile caps (Table 5), the performance of GMDH2 and GMDH2SCE models in predicting scour depth was better than other models (R=0.878, RMSE=3.272, MAPE=1.052, BIAS=0.386, SI=0.352 and R=0.877, RMSE=3.310, MAPE=1.072, BIAS=0.438, SI=0.356, respectively).

This study further compared AI technique estimates, with estimates produced by several empirical equations that have been widely applied to scour depth prediction. These approaches include HEC-18 (Richardson and Davis 2001), FDOT, Coleman [2], revised HEC-18 and revised Coleman procedures. These five empirical approaches generated significantly poorer values for the five criteria than that generated by the GMDH models.

Figure 8 shows the plotted graph between the predicted and observed values of scour depth obtained using GMDH models and five empirical approaches. The lines -20% and +20% represents the ratio of predicted scour depth to measured scour depth, when a dot is placed between these two lines, it means that the ratio of predicted values to measured values lies in the range between -0.2 and +0.2. As it can be seen roughly 58% of the values predicted by GMDH2SCE lie between $\pm 20\%$ error margin of perfect agreement, while 46%, 53%, 50%, 47%, and 54% of the values predicted by the GMDH1, GMDH1HS, GMDH1SCE, GMDH2, and GMDH2HS models, respectively, achieved the same margin. However, with scour depths estimated by HEC-18, FDOT, Coleman [2], revised HEC-18, and revised Coleman methods; 33%, 25%, 32%, 40%, and 17%, of data points respectively, lie between $\pm 20\%$ error margin.

Table 2. Results comparison with DDM techniques for series 1 (when the pile cap was above the initial bed level)

Model	Train					Test				
	R	RMSE	MAPE	BIAS	SI	R	RMSE	MAPE	BIAS	SI
GMDH1	0.900	1.355	0.160	5.60E-16	0.230	0.910	1.848	0.788	0.490	0.247
GMDH1HS	0.912	1.273	0.160	0.065	0.216	0.900	1.782	0.745	0.277	0.244
GMDH1SCE	0.926	1.171	0.144	-9.09E-10	0.199	0.923	1.602	0.663	0.288	0.218
GMDH2	0.895	1.389	0.171	0.086	0.236	0.909	1.937	0.755	0.463	0.260
GMDH2HS	0.926	1.171	0.144	-2.82E-09	0.199	0.888	1.824	0.805	0.189	0.251
GMDH2SCE	0.932	1.121	0.138	1.39E-14	0.190	0.923	1.602	0.663	0.288	0.218

Table 3. Results comparison with DDM techniques for series 2 (partially buried pile cap)

Model	Train					Test				
	R	RMSE	MAPE	BIAS	SI	R	RMSE	MAPE	BIAS	SI
GMDH1	0.785	3.186	31.685	3.13E-15	0.406	0.856	3.239	35.988	1.106	0.389
GMDH1HS	0.817	2.965	0.181	5.42E-08	0.378	0.856	3.239	35.988	1.106	0.388
GMDH1SCE	0.850	2.744	0.190	0.006	0.350	0.856	3.239	35.988	1.106	0.395
GMDH2	0.819	2.945	0.189	4.52E-15	0.375	0.856	3.239	35.988	1.106	0.344
GMDH2HS	0.838	2.918	0.183	0.663	0.362	0.856	3.239	35.988	1.106	0.337
GMDH2SCE	0.828	2.886	25.712	0.047	0.368	0.856	3.239	35.988	1.106	0.308

Table 4. Results comparison with DDM techniques for series 3 (completely buried pile cap)

Model	Train					Test				
	R	RMSE	MAPE	BIAS	SI	R	RMSE	MAPE	BIAS	SI
GMDH1	0.892	3.038	0.244	-7.28E-16	0.378	0.884	3.437	1.089	0.714	0.362
GMDH1HS	0.894	3.012	0.245	-0.001	0.375	0.887	3.406	1.083	0.753	0.357
GMDH1SCE	0.927	2.514	0.228	-1.49E-08	0.313	0.885	3.422	1.086	0.712	0.360
GMDH2	0.925	2.552	0.231	0.001	0.317	0.878	3.272	1.052	0.386	0.350
GMDH2HS	0.924	2.572	0.232	0.010	0.320	0.874	3.339	1.083	0.410	0.357
GMDH2SCE	0.928	2.510	0.228	-0.010	0.312	0.877	3.31	1.072	0.438	0.353

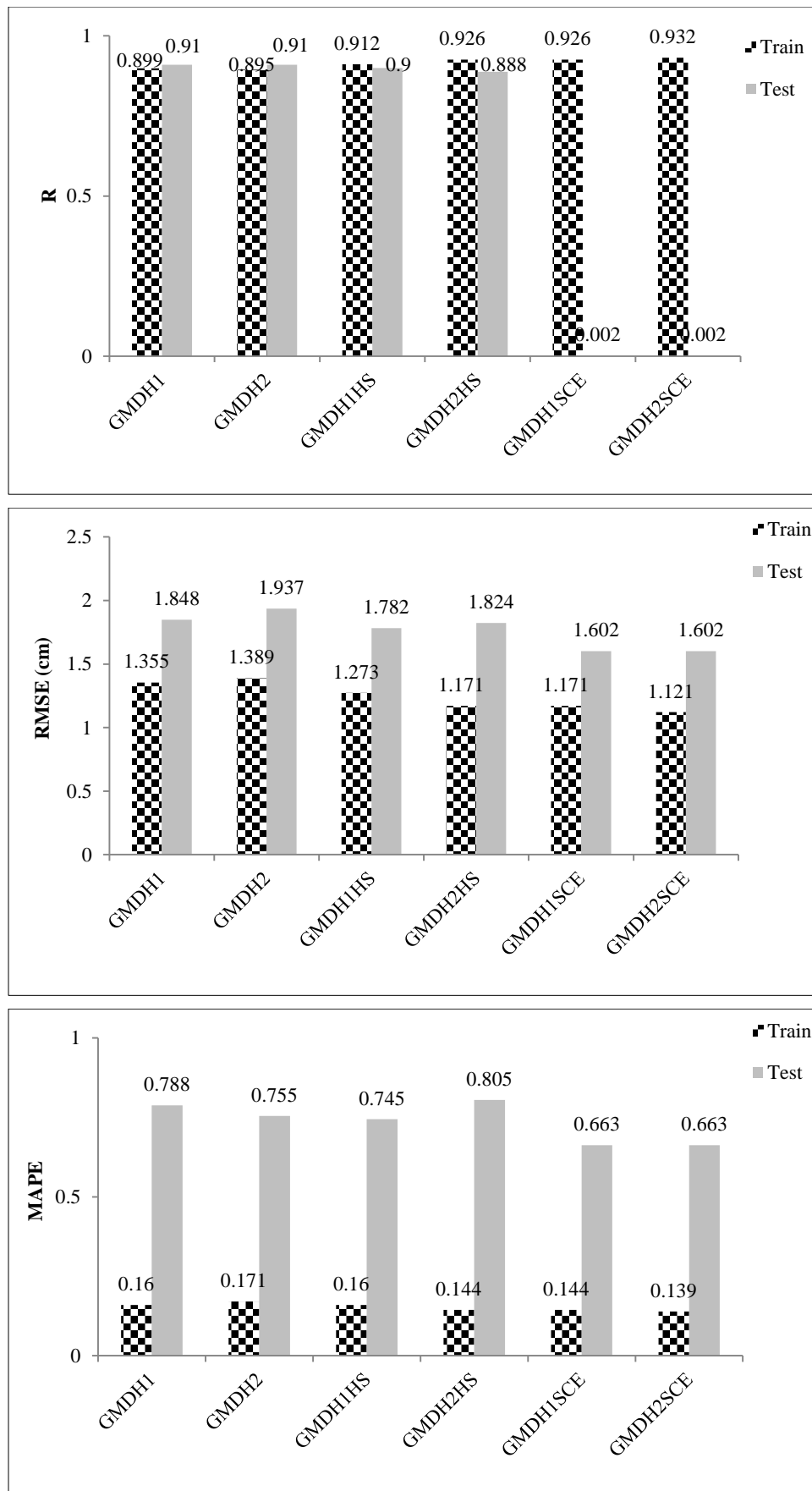

Figure 5. Evaluation criteria for data series 1 (when pile cap was above the initial bed level)

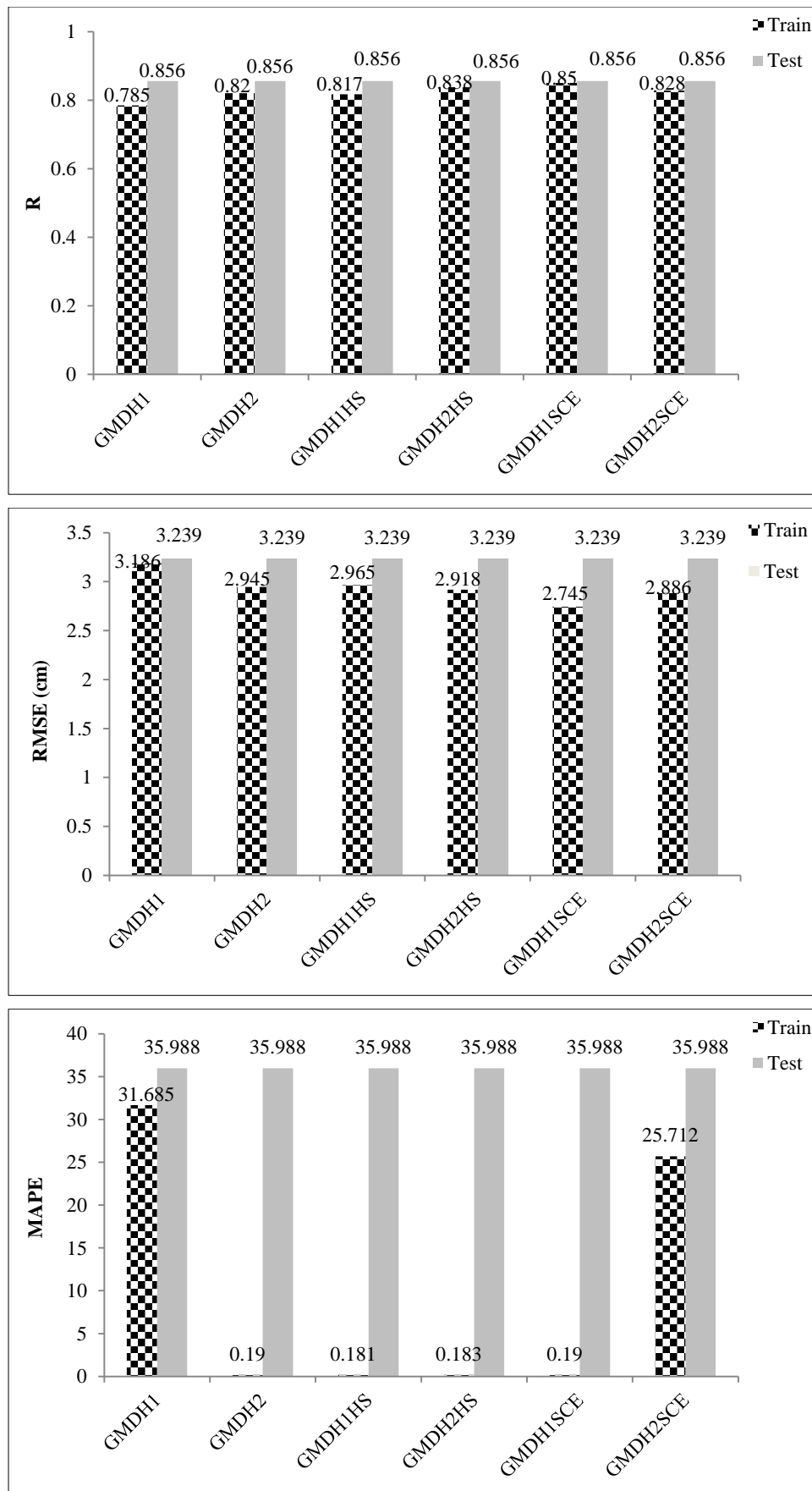

Figure 6. Evaluation criteria for data series 1 (semi buried pile cap)

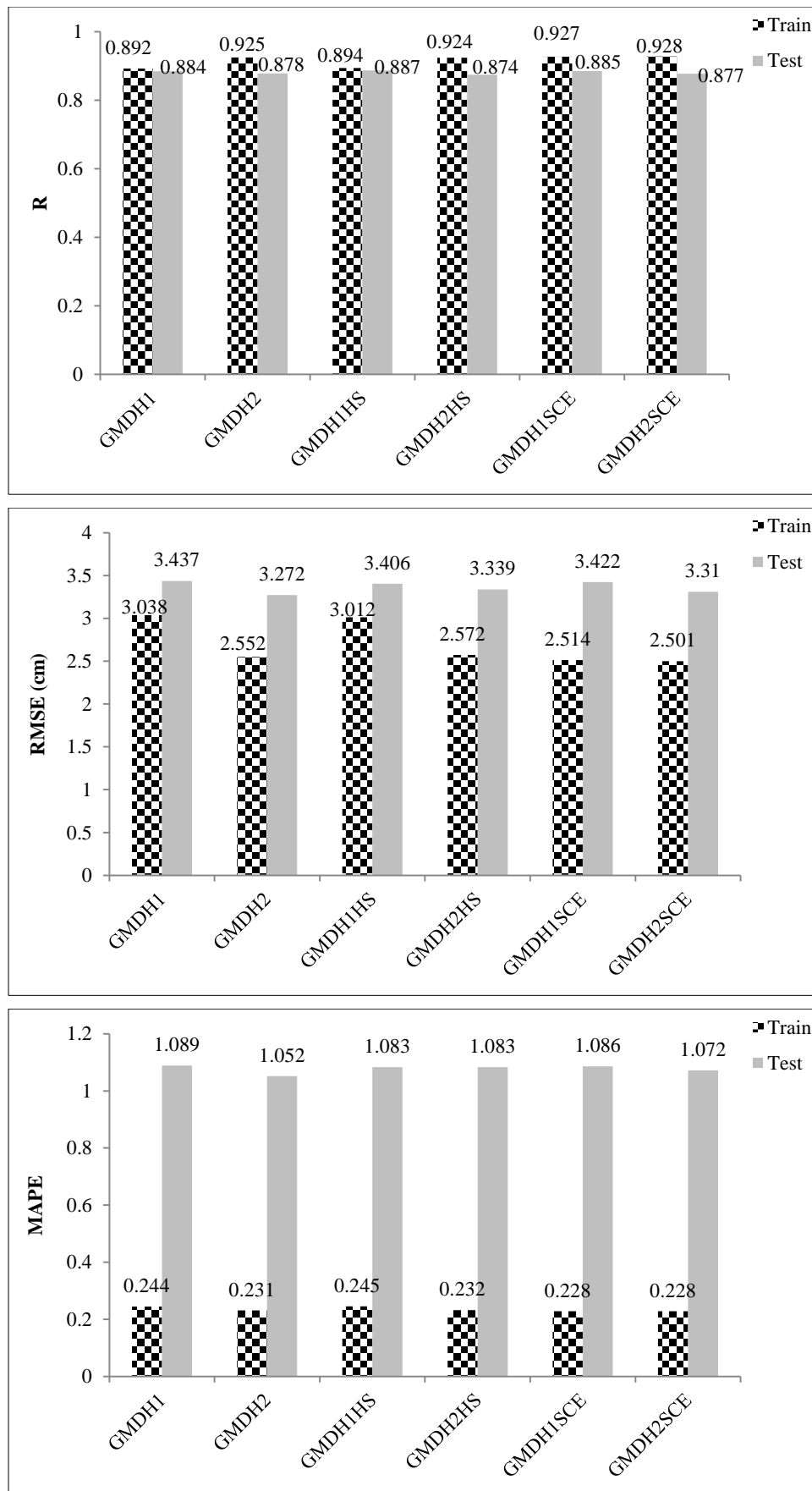
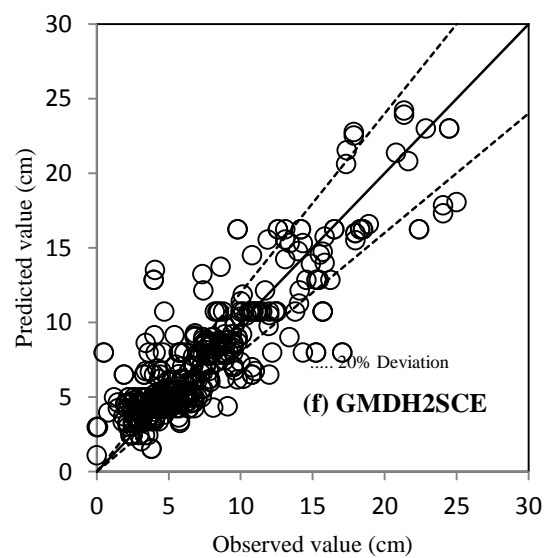
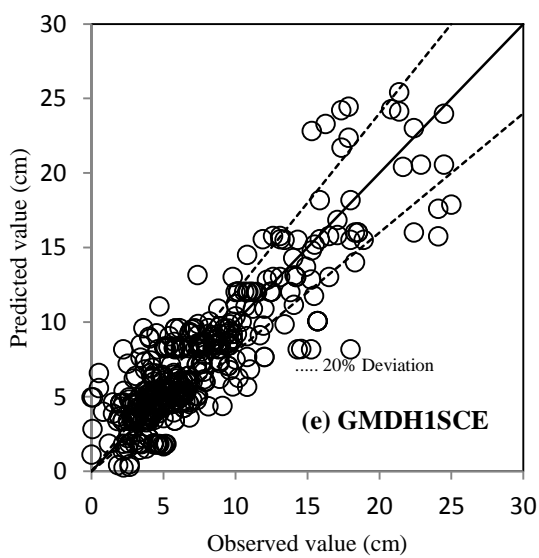
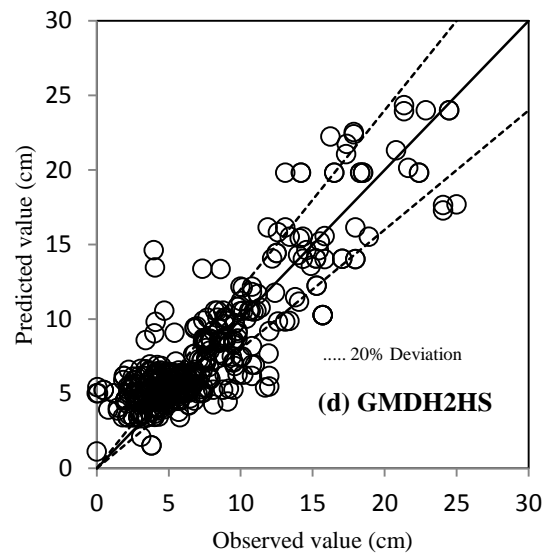
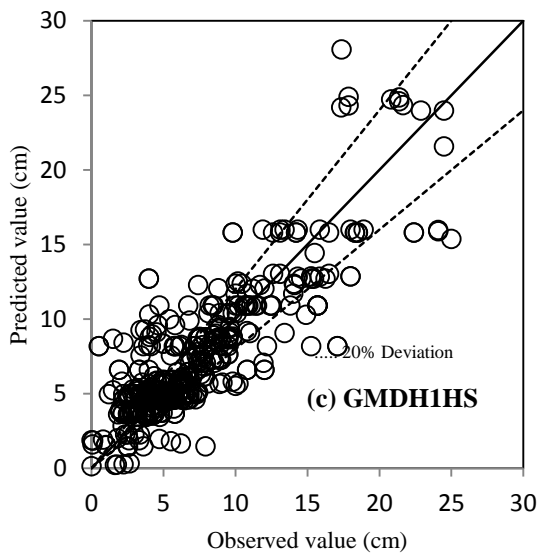
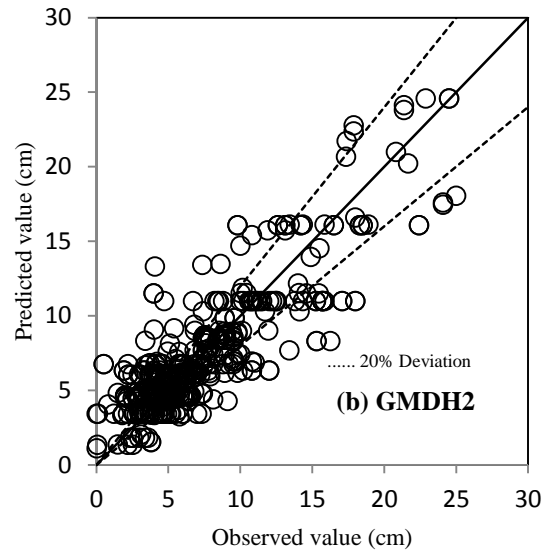
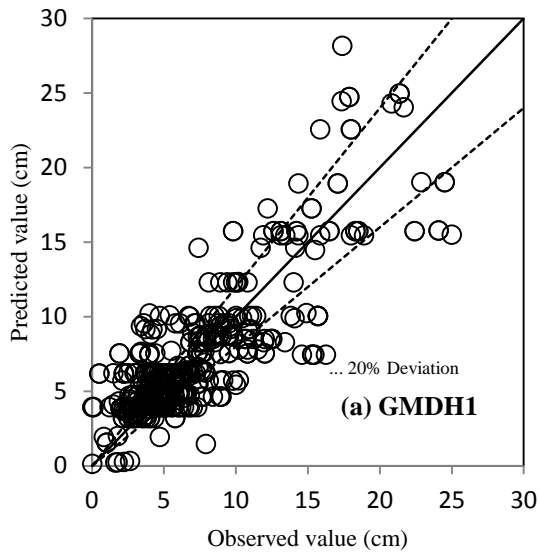

Figure 7. Evaluation criteria for data series 1 (completely buried pile cap)



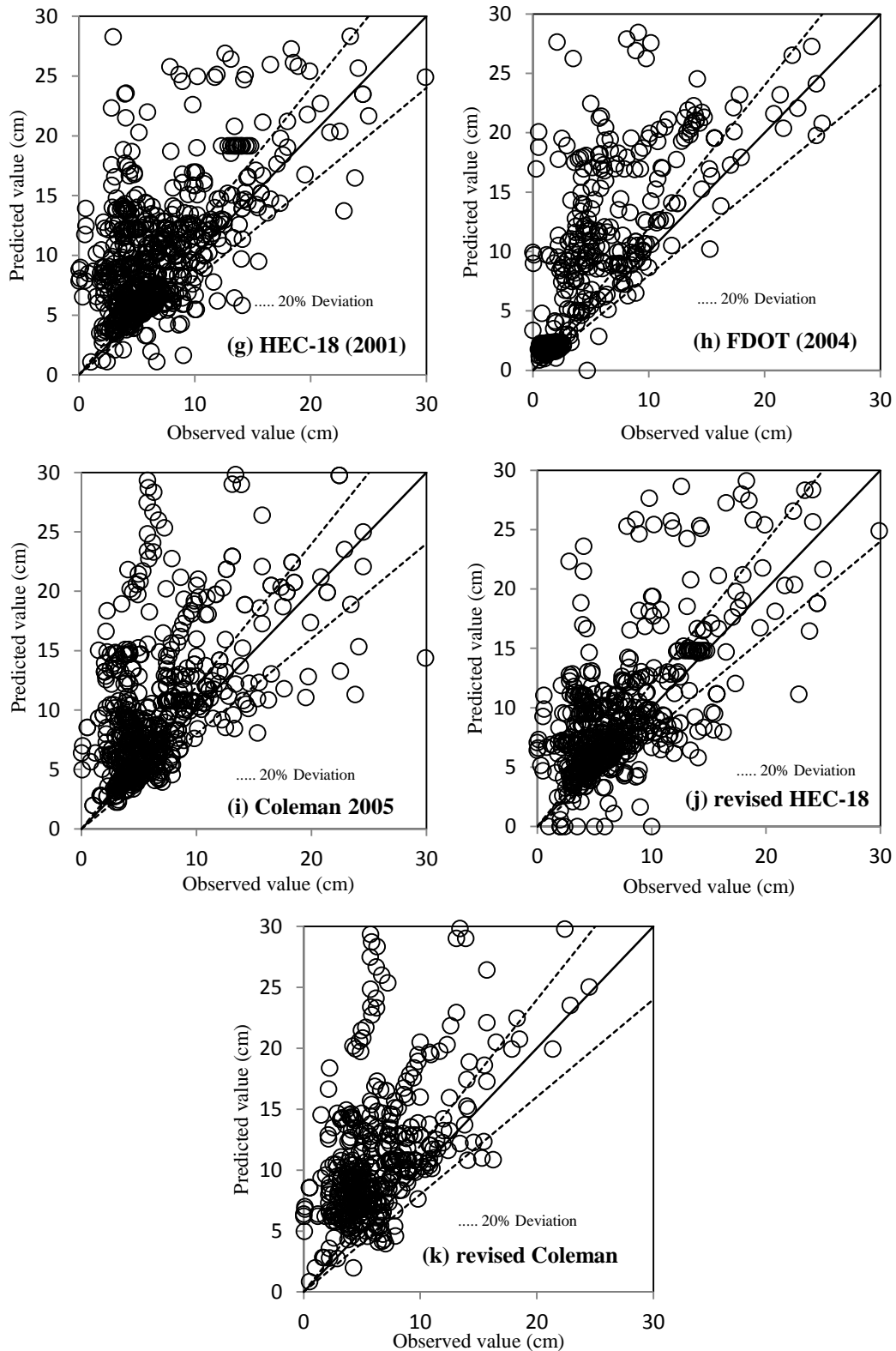

Fig. 8. Scatter plots of predicted versus observed scour depth

8. Conclusion

In this study, the hybrid GMDH model was developed to estimate scour depth around complex bridge piers under clear water conditions. The combination of GMDH with HS and SCE were utilized to predict scour depth around complex bridge piers. The empirical equations were applied for comparisons. Data sets campaigns of 82 data points measured by authors along with 615 data points collected from literature, which were used for training and testing stages. Data sets were divided into three categories based upon the pile cap situations. Statistical results for the training stage showed that GMDH2SCE produced an accurate estimation compared with other networks in data series 1 and 3,

respectively. Once, the pile cap was partially-buried GMDH1SCE had a better performance in scour depth prediction. Through the testing stage, GMDH2 estimated scour depth more accurately than others when the pile cap was above the initial bed level. All the networks estimated relatively same values for RMSE, MAPE, and correlation coefficient in the case of partially-buried pile cap. Also, GMDH1SCE predicted the best scour depth than other networks when the pile cap was completely buried. By considering statistical parameters such as R , RMSE, and MAPE it can be seen that hybrid GMDH models as data driven models are reliable in estimating scour depth around complex bridge piers.

9. Conflicts of Interest

The authors declare no conflict of interest.

10. In Memorial of Professor Mohammad Javad Khanjani

This paper is a part of the first author's dissertation which was supervised by Prof. Khanjani. Unfortunately, Prof. Khanjani passed away on November 27, 2019. He will be in our heart and mind forever.

11. References

- [1] Ghodsi H, Mohammad J.Khanjani, and Ali A. Beheshti. "Evolution of harmony search optimization to predict local scour depth around complex bridge piers." *Civil Engineering Journal* 4 no. 2 (2018):402-412. doi:10.28991/cej-0309100.
- [2] Melville, Bruce. W., and Stephen. E. Coleman. "Bridge scour." (2000) Water Resources Publications, Littleton, Colo.
- [3] Coleman, Stephen. E. "Clearwater local scour at complex piers." *Journal of Hydraulic Engineering* 131, no. 4 (2005):330-334. doi:10.1061/(ASCE)0733-9429(2005)131:4(330).
- [4] Ataie-Ashtiani, Behzad., Zahra Baratian-Ghorghi, and Ali. A.Beheshti. "Experimental investigation of clear-water local scour of compound piers." *Journal of Hydraulic Engineering* 136, no. 6 (2010):343-351. doi:10.1061/(ASCE)0733-9429(2010)136:6(343).
- [5] Ferraro, Domenico., Ali Tafarjnoruz., Roberto Gaudio, and Antonio H. Cardoso. "Effects of pile cap thickness on the maximum scour depth at a complex pier." *Journal of Hydraulic Engineering* 139, no. 5 (2013):482-491. doi:10.1061/(ASCE)HY.1943-7900.0000704.
- [6] Amini, Ata., and Tamer A. Mohamed. "Local scour prediction around piers with complex geometry." *Marine Geosoursec & Geotechnology* 35, no. 6 (2017):857-864. doi:10.1080/1064119X.2016.1256923.
- [7] Bateni, Sayed. M., Dong S. Jeng. "Estimation of pile group using adaptive neuro-fuzzy approach." *Ocean. Engineering* 34 (2007):1344-1354. doi:10.1016/j.oceaneng.2006.07.003.
- [8] Zounemat-Kermani, Mohammad., Ali A. Beheshti, Behzad Ataie-Ashtiani, B., Saied R. Sabbagh-Yazdia. "Estimation of current-induced scour depth around pile groups using neural network and adaptive neuro-fuzzy inference system." *Applied Soft Computing* 9, no. 2 (2009):746-755. doi:10.1016/j.asoc.2008.09.006.
- [9] Najafzadeh, Mohammad., Amir Etemad-Shahidi, and Siow Y.Lim. "Scour prediction in long contractions using ANFIS and SVM." *Ocean Engineering* 111 (2016):128-135. doi:10.1016/j.oceaneng.2015.10.053.
- [10] Najafzadeh, Mohammad., Mohammad Rezaie-Balf, and Esmat Rashedi. "Prediction of maximum scour depth around piers with debris accumulation using EPR, MT, and GEP models." *Journal of Hydroinformatics* 18, no. 5 (2016):867-883. doi:10.2166/hydro.2016.212.
- [11] Sharafi, Hassan., Isa Ebtehaj, Hossein Bonakdari, Amir H. Zaji. "Design of a support vector machine with different kernel functions to predict scour depth around bridge piers." *Natural Hazards* 84, no. 3 (2016):2145-2162. doi:10.1007/s11069-016-2540-5.
- [12] Ebtehaj, Isa., Ahmed A. M. Sattar, Hossein Bonakdari, and Ami H. Zaji. "Prediction of scour depth around bridge piers using self-adaptive extreme learning machine." *Journal of Hydroinformatics* 19, no. 2 (2017):207-224. doi:10.2166/hydro.2016.025.
- [13] Aminoroayaie Yamini, O., S. Hooman Mousavi, Mohammad R. Kavianpour, and, Azin Mahdavi. "Numerical modeling of sediment scouring phenomenon around the offshore wind turbine pile in marine environment." *Environment Earth Sciences* 77, (2018):207-224. doi:10.1007/s12665-018-7967-4.
- [14] Najafzadeh, Mohammad., Jalal Shiri, and, Mohammad Rezaie Balf. "New expressions-based models to estimate scour depth at clear water conditions in rectangular channels." *Marine Georesources & Geotechnology* 36, no. 2 (2017):227-235. doi:10.1080/1064119X.2017.1303009.
- [15] Parsaie, Abbas., Amir H. Haghiabi, Mojtaba Saneie, and, Hasan Torabi. "Applications of soft computing for prediction of energy dissipation on stepped spillways." *Neural Comput & Applic* 29, no. 12 (2018):1393-1409. doi:10.1007/s00521-016-2667-z.

- [16] Sreedhara, B. M., Manu Rao, and, Sukomal Mandal. "Application of an evolutionary technique (PSO-SVM) and ANFIS in clear-water scour depth prediction around bridge piers." *Neural Computing and Applications* 31, no. 11 (2019):7335-7349. doi:10.1007/s00521-018-3570-6.
- [17] Najafzadeh, Mohammad., and Gholam A. Barani. "Comparison of group method of handling based genetic programming and back propagation systems to predict scour depth around bridge piers." *Scientia Iranica*. 18, no. 6 (2011):1207-1213. doi:10.1016/j.scient.2011.11.017
- [18] Najafzadeh, Mohammad., and Hazi M. Azamathulla. "Group method of data handling to predict scour depth around bridge piers." *Neural Computing and Application* 23, no. 7-8 (2012):2107-2112. doi:10.1007/s00521-012-1160-6.
- [19] Najafzadeh, Mohammad., Golam A. Barani, and Masoud R. Hessami-Kermani. "GMDH network based back propagation algorithm to predict abutment scour in cohesive soils." *Ocean Engineering*, 59 (2013):100-106. doi:10.1016/j.oceaneng.2012.12.006
- [20] Najafzadeh, Mohammad., Farid Saberi Movahed, and, Saeed Sarkamaryan. "NF-GMDH based self-organized systems to predict bridge pier scour depth under debris flow effects." *Marine Georesources & Geotechnology* 36, no. 5 (2018):589-602. doi:10.1080/1064119X.2017.1355944.
- [21] Raudkivi, Arved. J. "Functional trends of scour at bridge piers." *Journal of Hydraulic Engineering* 112, no. 1 (1986):1-13. doi:10.1061/(ASCE)0733-9429(1986)112:1(1).
- [22] Melville, Bruce. W. "Pier and abutment scour: integrated approach." *Journal of Hydraulic Engineering* 123, no. 2 (1997):125-136. doi:10.1061/(ASCE)0733-9429(1997)123:2(125)
- [23] Ettema, Robert., Bruce. W., Melville, and Brain Barkdoll. "Scale effects in pier-scour experiments." *Journal of Hydraulic Engineering* 124, no. 6 (1998):639-642. doi:10.1061/(ASCE)0733-9429(1998)124:6(639).
- [24] Salim, Mohammad., and J. Sterling Jones. "Scour around exposed pile foundations." *Compilation of Conf. Scour Papers (1991-1998)*, ASCE, Reston, VA.
- [25] Zhao, Gang., and D. Max Sheppard. "The effect of skew angle on sediment scour near pile groups." *Compilation of Conf. Scour Papers (1991-1998)*, ASCE, Reston, VA.
- [26] Ataie-Ashtiani, Behzad., and Ali A. Beheshti. "Experimental investigation of clear-water local scour at pile groups." *Journal of Hydraulic Engineering* 132, no. 10 (2006):1100-1104. doi:10.1061/(ASCE)0733-9429(2006)132:10(1100).
- [27] Sumer, B. Mutlu., Klavs Bundgaard, and Jørgen Fredsøe. "Global and local scour at pile group." *15 th Int. Offshore and Polar Eng. Conf., Int. Society of Offshore and Polar Enginners, Seoul, Korea, (2005) 577-583.*
- [28] Dey, Subhasish., Rajkumar V. Raikar, and Abhishek Roy. "Scour at submerged cylindrical obstacles under steady flow." *Journal of Hydraulic Engineering* 134, no. 1 (2008):105-109. doi:10.1061/(ASCE)0733-9429(2005)131:4(330).
- [29] Amini, Ata., Bruce W. Melville, M. Ali Thamer, and Abdul H. Ghazali. "Clear-water local scour around pile groups in shallow-water flow." *Journal of Hydraulic Engineering* 138, no. 2 (2012):177-185. doi:10.1061/(ASCE)HY.1943-7900.0000488.
- [30] Melville, Bruce, and Arved J. Raudkivi. "Effects of foundation geometry on bridge pier scour." *Journal of Hydraulic Engineering* 122, no. 4 (1996):203-209. doi:10.1061/(ASCE)0733-9429(1996)122:4(203).
- [31] Richardson, Everret V., Davis, S.R. "Evaluating Scour at Bridges." *Hydraulic Engineering Circular No. 18 (HEC-18)*, 4rd Ed. (2001), Rep. No. FHWA NHI 01-001, Federal Highway Administration, Washington, D.C.
- [32] Sheppard, D. Max, Tom L. Glasser. "Sediment scour at piers with complex geometries." *Proc., 2004 2nd Int. Conf. on Scour and Erosion*, World Scientific, Singapore.
- [33] Beheshti, Ali. A., and Behzad Ataie-Ashtiani. "Experimental study of three-dimensional flow field around a complex bridge pier." *Journal of Engineering Mechanics* 136, no. 2 (2010):143-154. doi:10.1061/(ASCE)EM.1943-7889.0000073.
- [34] Lu, Jau. Y., Zhong Z. Shi, Jian H. Hong, Jun j. Lee, and Rajkumar V. Raikar. "Temporal variation of scour depth at nonuniform cylindrical piers." *Journal of Hydraulic Engineering* 137, no. 1 (2011):45-56. doi:10.1061/(ASCE)HY.1943-7900.0000272.
- [35] Kumar, Ashish, and Umesh C. Kothiyari. "Three-dimensional flow characteristics within the scour hole around circular uniform and compound piers." *Journal of Hydraulic Engineering* 138, no. 5 (2012):420-429. doi:10.1061/(ASCE)HY.1943-7900.0000527.
- [36] Amini-Baghdadorani, Daniel., Behzad Ataie-Ashtiani, Ali A. Beheshti, Mohammad Hajzaman, and Mirmosadegh Jamali. "Preiction of current-induced local scour around complex piers: review, revisit, and integration." *Coastal Engineering*. 133 (2018):43-58. doi: 10.1016/j.coastaleng.2017.12.006.

- [37] Yang, Yifan., Bruce. W. Melville, D. Max. Sheppard, and Assad Y. Shamseldin. "Clear-water local scour at skewed complex bridge piers." *Journal of Hydraulic Engineering* 144, no. 6 (2018). doi:10.1061/(ASCE)HY.1943-7900.0001458.
- [38] Hannah, C. R.. Scour at pile groups. Res. Rep. No. 28-3(1978), Dept. of Civil Engineering, Univ. of Canterbury, Christchurch, New Zeland.
- [39] Martín-Vide, J. P., Hidalgo, C., and Bateman, A. "Local scour at piled bridge foundations." *Journal of Hydraulic Engineering* 124, no. 4 (1998):439-444. doi:10.1061/(ASCE)0733-9429(1998)124:4(439).
- [40] Parola, A. C., Mahdavi, S. K., Brown, B. M., and El Khoury, A. "Effects of rectangular foundation geometry on local pier scour." *Journal of Hydraulic Engineering* 122, no. 1 (1996):35-40. doi:10.1061/(ASCE)0733-9429(1996)122:1(35).
- [41] Fotherby, Lisa. M., and J. Sterling Jones. "The influence of exposed footing on pier scour depth." *Proc., (1993) Hydraulic Engineering Conf., ASCE, Reston, Va, 922-927.*
- [42] Oliveto, Giuseppe., Rossi, A., and Willi H. Hager. "Time-Dependent Local Scour at Piled Bridge Foundations." *Hydraulics of Dams and River Structures, (2004) Taylor & Francis Group, London.*
- [43] Najafzadeh, Mohammad. "Neuro-fuzzy GMDH system based particle swarm optimization for prediction of scour depth at downstream of grade control structures." *Engineering Science and Technology, an International Journal* 18, no. 1 (2015):42-51. doi:10.1016/j.jestch.2014.09.002.
- [44] Godfery, C. Onwubolu. "Hybrid self-Organizing Modeling Systems" Vol. 211 (2009), Springer-Verlag Berlin Heidelberg, United States of America.